



17 marca 2019

Rally Mazowsze

Pod Patronatem:
Biuletynu Naczelnej Organizacji Mazowieckiej
i Pucharu Beniamina Rowlesów Okręgu Mazowieckiego
i Pucharu Międzyczłonkowskiego nad Wisłą

I Runda Samochodowych Mistrzostw Pucharu AKC
I Runda Rajdowego Pucharu PZM SOS

KSIĄŻKA DROGOWA RALLY MAZOWSZE

I Runda Samochodowych Mistrzostw Pucharu AKC
I Runda Rajdowego Pucharu PZM SOS



www.ak-centrum.pl

ETAP 1 (Sekcja 1,2)		niedziela, 17 marzec 2019				
PKC PS		PS dług.	Dojazd.	Odcinek drogowy	Czas przejazdu	Czas 1. załogi
START	Nowy Dwór Mazowiecki Urząd Miasta	-	-	-	-	09:15
1	Nowy Dwór Mazowiecki	-	1,00	1,00	00:14	09:29
PS 1	Nowy Dwór Mazowiecki	1,23	-	-	-	09:31
2	Okunin	-	2,40	3,63	00:20	09:51
PS 2	Okunin	1,38	-	-	-	09:53
3	Goławin	-	23,50	24,88	01:02	10:55
PS 3	Goławin	1,82	-	-	-	10:57
SERWIS A		(4,43)	(26,90)	(29,51)	00:15	
4	Nowy Dwór Mazowiecki	-	21,10	25,53	00:52	12:04
PS 4	Nowy Dwór Mazowiecki	1,23	-	-	-	12:06
5	Okunin	-	2,40	3,63	00:08	12:12
PS 5	Okunin	1,38	-	-	-	12:14
6	Goławin	-	23,50	24,88	00:50	13:02
PS 6	Goławin	1,82	-	-	-	13:04
SERWIS B		(4,43)	(47,00)	(54,04)	00:15	
7	Nowy Dwór Mazowiecki	-	21,10	25,53	00:52	14:11
PS 7	Nowy Dwór Mazowiecki	1,23	-	-	-	14:13
8	Okunin	-	2,40	3,63	00:08	14:19
PS 8	Okunin	1,38	-	-	-	14:21
9	Goławin	-	23,50	24,88	00:50	15:09
PS 9	Goławin	1,82	-	-	-	15:11
META	Zakroczym Karczma pod Jaworem	-	11,00	12,82	00:26	15:35
ETAP 1 łącznie		13,29	131,90	150,41	8,8%	

Sekcja 1

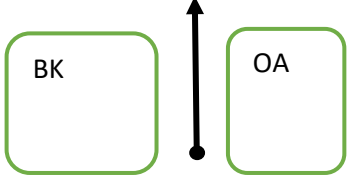
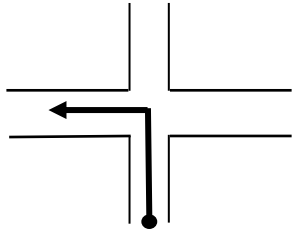

Sekcja 2

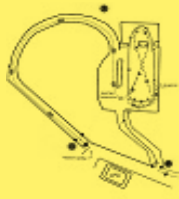
Sekcja 3

PKC	START	Nowy Dwór Mazowiecki Urząd Miasta	Dystans	Etap 1	Strona
PKC	START	Nowy Dwór Mazowiecki Urząd Miasta	0,36 km	Sekcja 1	1
				Prędkość	
				30 km/h	Czas
					1 min.
Dystans		Kierunek		Informacje	
Total	Pomiędzy			Do końca	
	0,00			wyjazd z BK / OA	
	0,13			ul. Zachodnia	
	0,23			PKC 1	
	0,00			PS 1	

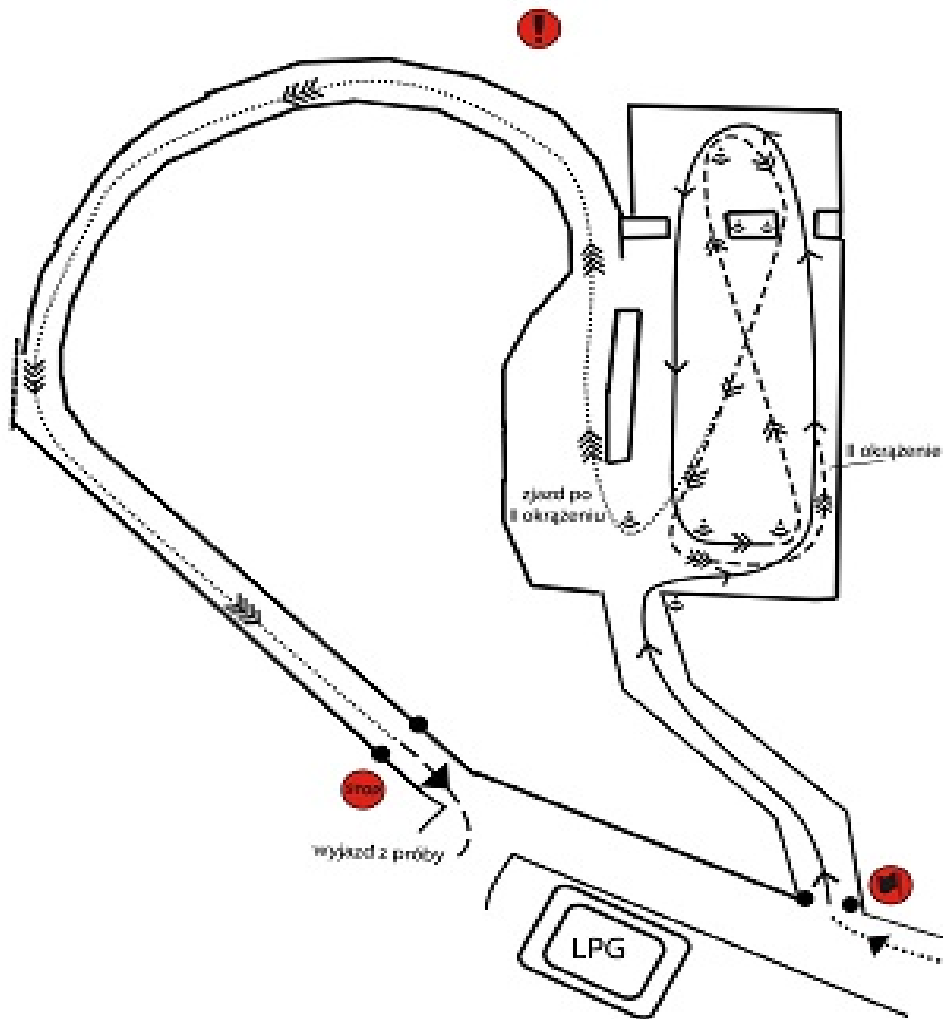
PKC	START	Nowy Dwór Mazowiecki Urząd Mi	Dystans	Etap 1	Strona
PKC	1	Nowy Dwór Mazowiecki	0,00 km	Sekcja 1	2
			Prędkość	Czas	0 min.
			30 km/h		
Nowy Dwór Mazowiecki					

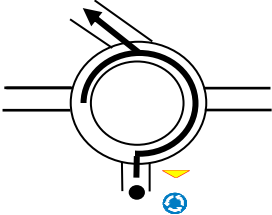
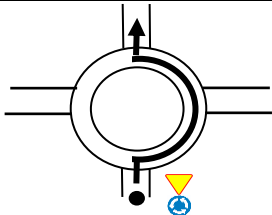
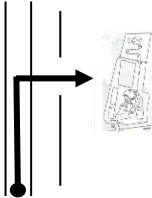



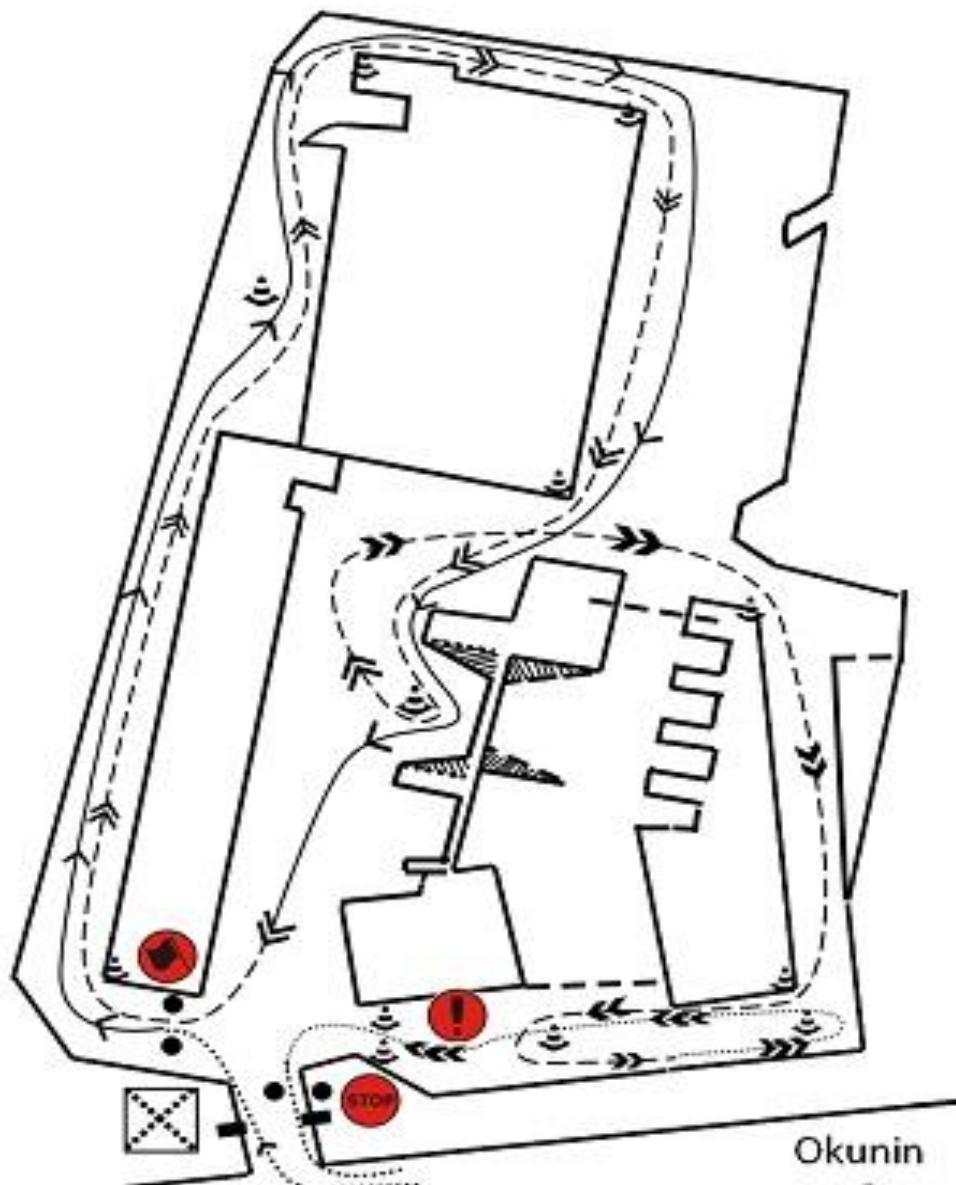

PKC PKC	1	Nowy Dwór Mazowiecki	Dystans	Etap 1	Strona
	2	Okunin	0,00 km	0	3
			Prędkość	Czas	0 min.
			30 km/h		
Dystans		Kierunek	Informacje	Do końca	
Total	Pomiędzy				
	0,00		Wyjazd z próby na rondzie drugi zjazd w ul. Modlińska		
	1,90		Na rondzie drugi zjazd ul Bohaterów Modlina		
	1,40		Wjazd na próbę		
	0,40		PKC 2		
	0,00		PS 2		

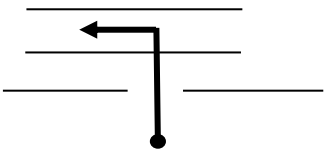
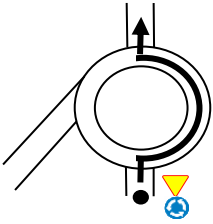
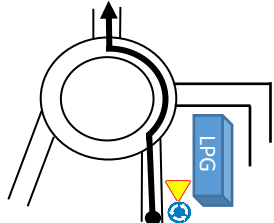
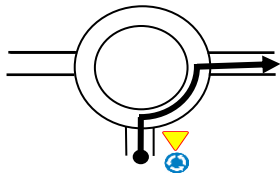
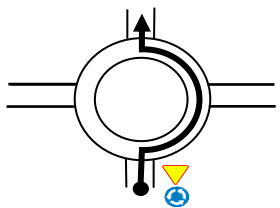
PKC	1	Nowy Dwór Mazowiecki	Dystans	Etap 1	Strona
PKC	2	Okunin	0,00 km	0	4
			Prędkość	Czas	0 min.
			30 km/h		
Okunin					

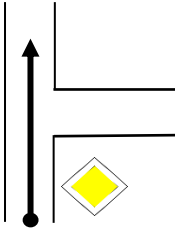
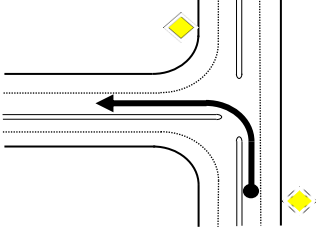

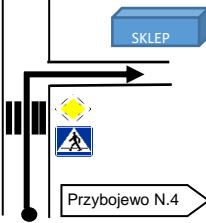
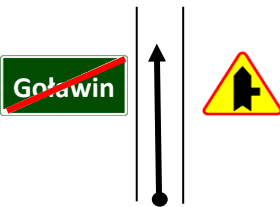
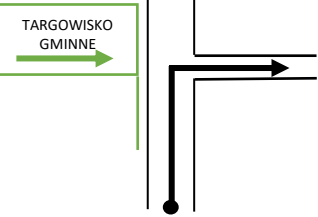

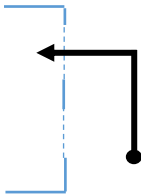
PKC	2	Okunin	Dystans	Etap 1	Strona
PKC	3	Goławin	7,25 km	0	5
			Prędkość	Czas	15 min.
			30 km/h		
Dystans		Kierunek	Informacje	Do końca	
Total	Pomiędzy				
	0,30		Wyjazd z próby		
	2,10		Na rondzie pierwszy zjazd ul. Bohaterów Modlina		
	0,55				
	0,20		Na rondzie pierwszy zjazd w drogę nr 85 w kierunku Płock		
	4,10				

PKC PKC	2	Okunin	Dystans	Etap 1	Strona
	3	Goławin	12,00 km	0	6
			Prędkość	Czas	24 min.
			30 km/h		
Dystans		Kierunek	Informacje	Do końca	
Total	Pomiędzy				
	1,00		Jedź prosto w drogę 62		
	9,80		Skręć w lewo w drogę nr 62 kierunek: Płock		
	0,60		Za przejściem dla pieszych skręć w prawo w kierunku Przybojowo N.		
	0,00				
	0,60				

PKC	2	Okunin	Dystans	Etap 1	Strona
PKC	3	Goławin	1,00 km	0	7
			Prędkość	Czas	2 min.
			30 km/h		
Dystans		Kierunek	Informacje	Do końca	
Total	Pomiędzy				
	0,60		Wjazd na próbę bramą nr 2		
	0,40		PKC 3		
	0,00		PS 3		

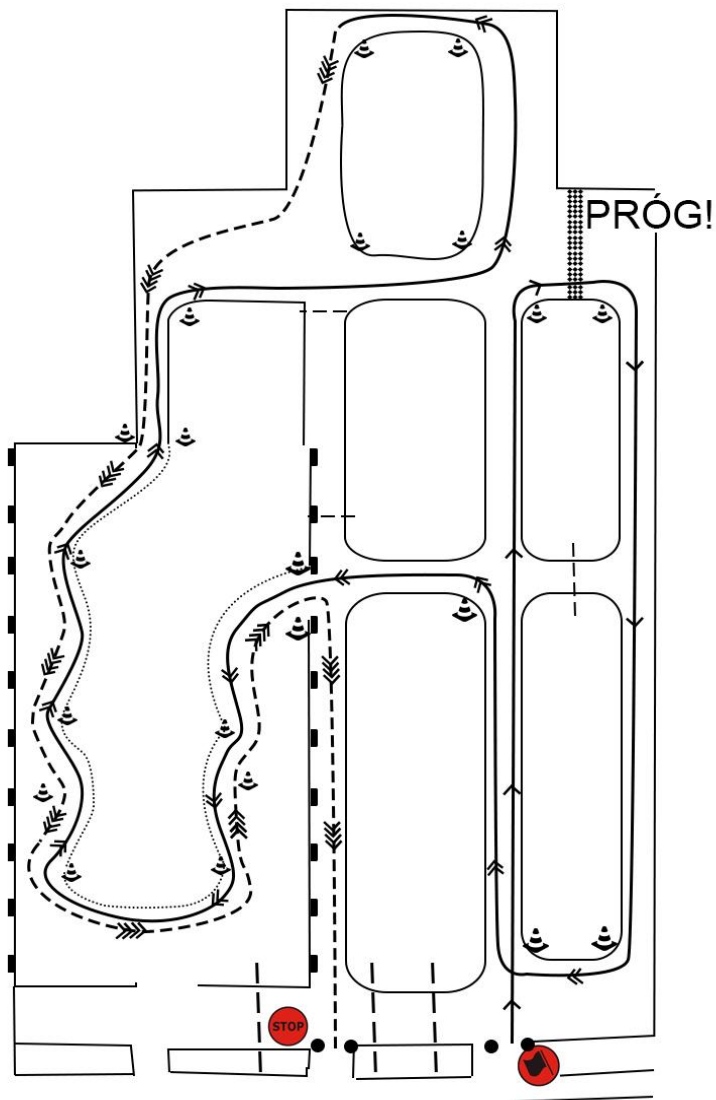
PKC	2	Okunin	Dystans	Etap 1	Strona
PKC	3	Goławin	0,00 km	0	8
			Prędkość	Czas	0 min.
			30 km/h		
Goławin					

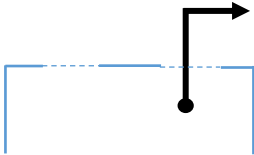
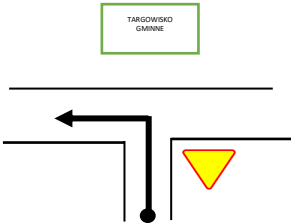
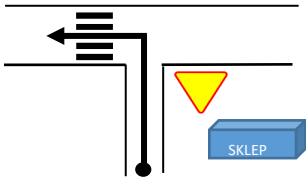
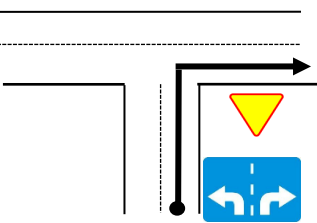
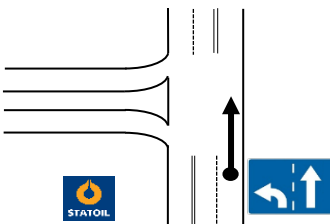

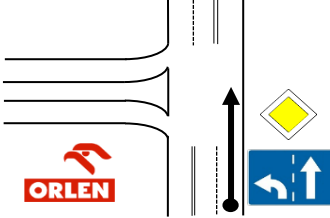
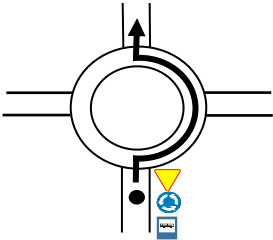
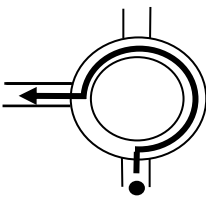
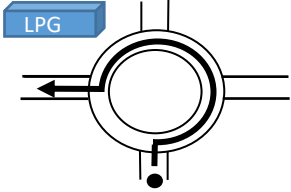
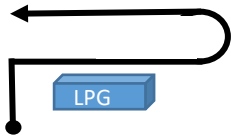

PKC	3	Goławin	Dystans	Etap 1	Strona
PKC	4	Nowy Dwór Mazowiecki	0,00 km	0	9
			Prędkość	Czas	0 min.
			30 km/h		
Dystans		Kierunek	Informacje	Do końca	
Total	Pomiędzy				
	0,00		Wyjazd z próby		
	0,60		Skręć w lewo w kierunku Goławin		
	0,60		Skręć w lewo w drogę nr 62 w kierunku Warszawa		
	9,80		Jedź dalej w prawo drogą 62 w kierunku Warszawa		
	0,00		Jedź dalej drogą nr 62		

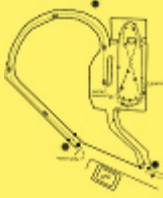
PKC	3	Goławin	Dystans	Etap 1	Strona
PKC	4	Nowy Dwór Mazowiecki	0,00 km	0	10
			Prędkość	Czas	0 min.
			30 km/h		
Dystans		Kierunek	Informacje	Do końca	
Total	Pomiędzy				
	7,80		Jedź prosto w drogę 85 w kierunku Warszawa		
	1,00		Na rondzie drugi zjazd w kierunku mostu		
	0,10		Skręć w lewo w drogę nr 631 w kierunku Centrum		
	0,57		Na rondzie trzeci zjazd w kierunku stacji LPG		
	0,14		Ustaw się za ostatnim autem w kolejce		

PKC	3	Goławin	Dystans	Etap 1	Strona
PKC	4	Nowy Dwór Mazowiecki	0,40 km	0	11
			Prędkość	Czas	1 min.
			30 km/h		
Dystans		Kierunek	Informacje		Do końca
Total	Pomiędzy				
	0,40		PKC 4		
	0,00		PS 4		

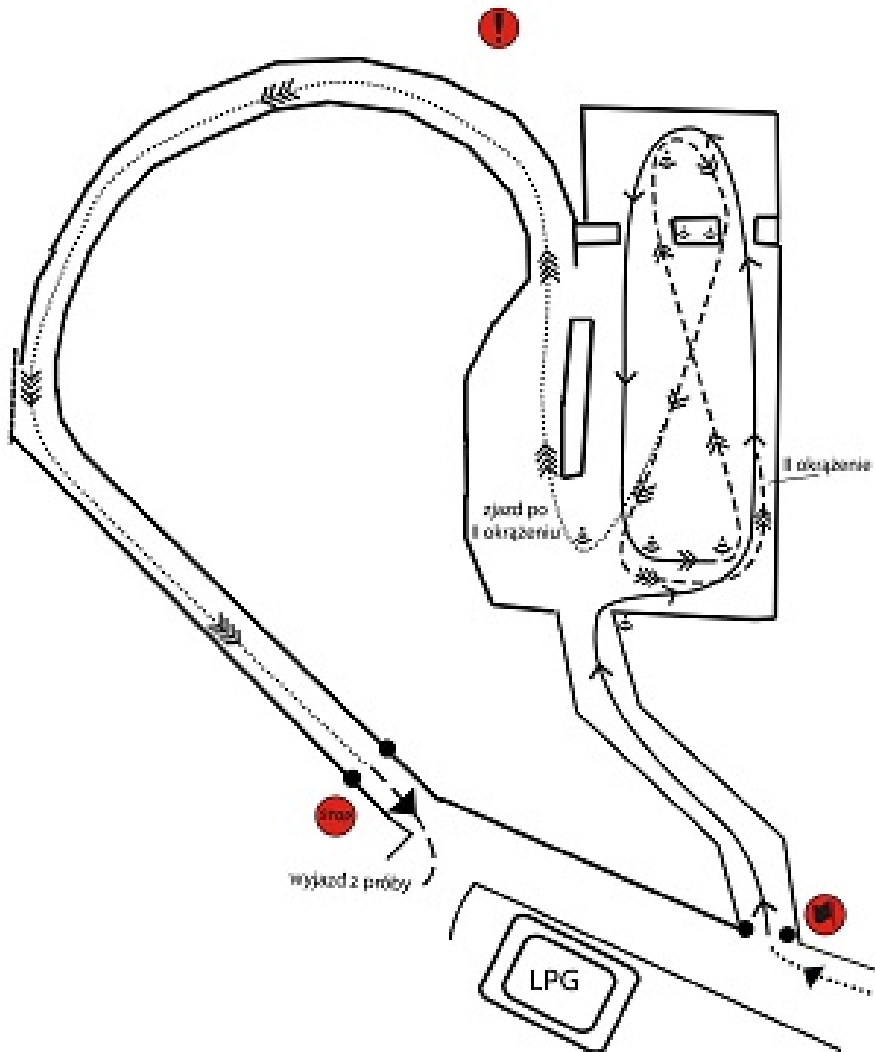
PKC	3	Goławin	Dystans	Etap 1	Strona
PKC	4	Nowy Dwór Mazowiecki	0,00 km	0	12
			Prędkość	Czas	0 min.
			30 km/h		
Nowy Dwór Mazowiecki					

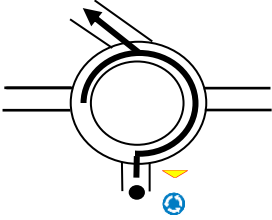
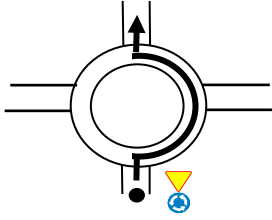
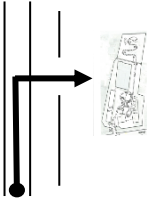

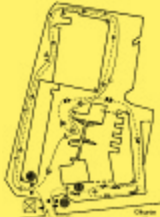

PKC	4	Nowy Dwór Mazowiecki	Dystans	Etap 1	Strona
PKC	5	Okunin	0,00 km	Sekcja 2	13
			Prędkość	Czas	0 min.
			30 km/h		
Dystans		Kierunek	Informacje	Do końca	
Total	Pomiędzy				
	0,50		Wyjazd z próby na rondzie drugi zjazd w ul. Modlińska		
	1,40		Na rondzie drugi zjazd ul Bohaterów Modlina		
	1,40		Wjazd na próbę		
	0,40		PKC 5		
	0,00		PS 5		

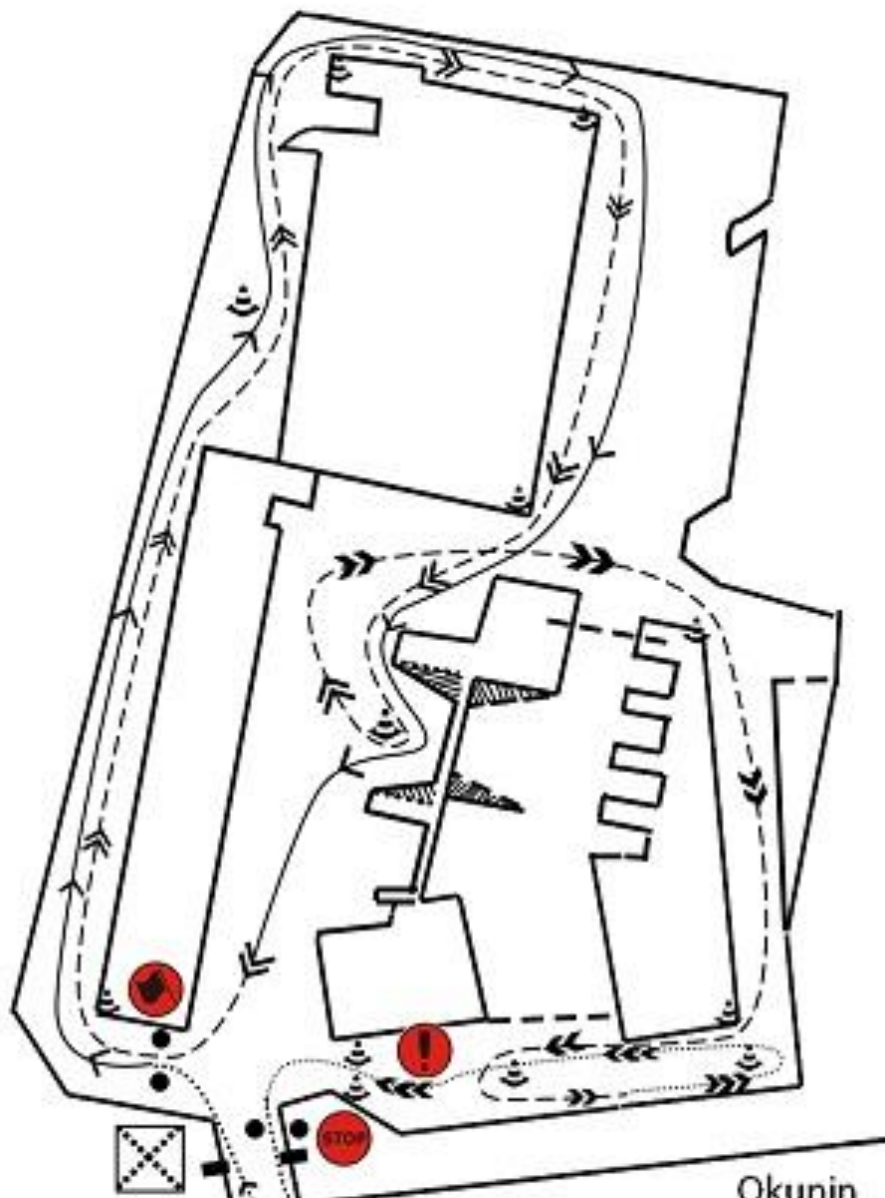
PKC	4	Nowy Dwór Mazowiecki	Dystans	Etap 1	Strona
PKC	5	Okunin	0,00 km	Sekcja 2	14
			Prędkość	Czas	0 min.
			30 km/h		
Okunin					

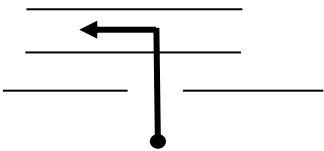
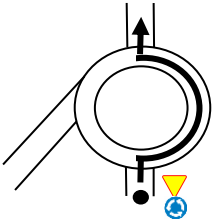
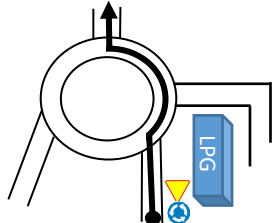
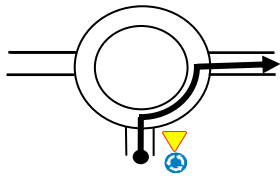
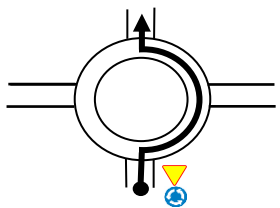

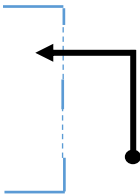

PKC	5	Okunin	Dystans	Etap 1	Strona
PKC	6	Goławin	7,25 km	0	15
			Prędkość	Czas	15 min.
			30 km/h		
Dystans		Kierunek	Informacje	Do końca	
Total	Pomiędzy				
	0,30		Wyjazd z próby		
	2,10		Na rondzie pierwszy zjazd ul. Bohaterów Modlina		
	0,55				
	0,20		Na rondzie pierwszy zjazd w drogę nr 85 w kierunku Płock		
	4,10				

PKC PKC	5	Okunin	Dystans	Etap 1	Strona
	6	Goławin	12,00 km	0	16
			Prędkość	Czas	24 min.
			30 km/h		
Dystans		Kierunek	Informacje	Do końca	
Total	Pomiędzy				
	1,00		Jedź prosto w drogę 62		
	9,80		Skręć w lewo w drogę nr 62 kierunek: Płock		
	0,60		Za przejściem dla pieszych skręć w prawo w kierunku Przybojowo N.		
	0,00				
	0,60				

PKC	5	Okunin	Dystans	Etap 1	Strona
PKC	6	Goławin	1,00 km	0	17
			Prędkość	Czas	2 min.
			30 km/h		
Dystans		Kierunek	Informacje	Do końca	
Total	Pomiędzy				
	0,60		Wjazd na próbę bramą nr 2		
	0,40		PKC 6		
	0,00		PS 6		

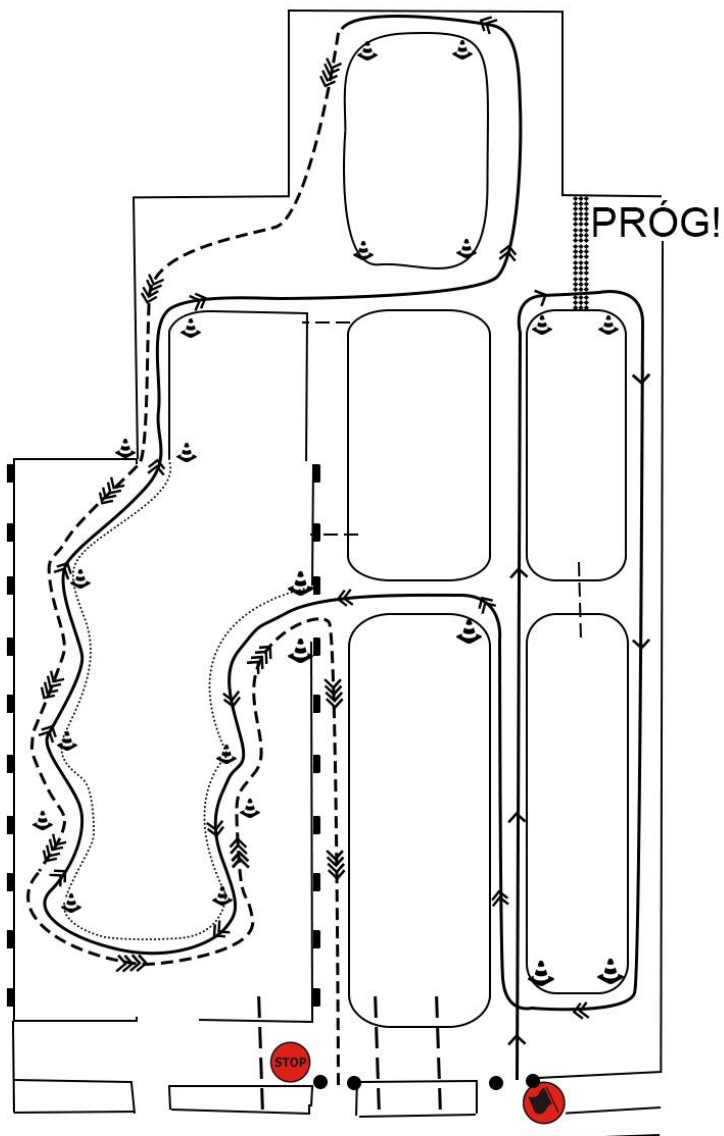
PKC	5	Okunin	Dystans	Etap 1	Strona
PKC	6	Goławin	0,00 km	0	18
			Prędkość	Czas	0 min.
			30 km/h		
Goławin					

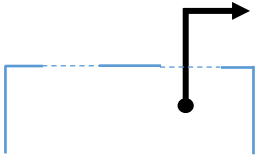
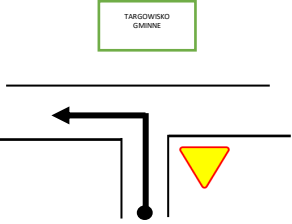
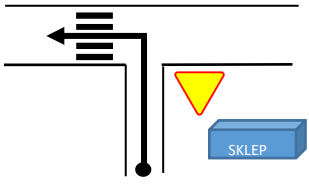
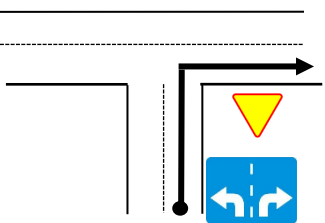

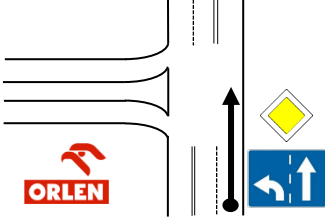
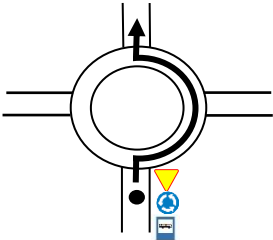
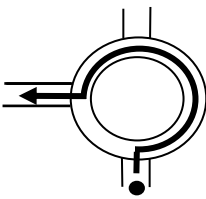
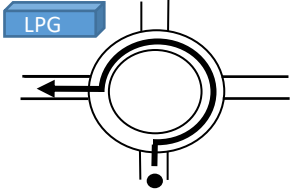
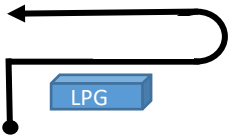

PKC	6	Goławin	Dystans	Etap 1	Strona
PKC	7	Nowy Dwór Mazowiecki	0,00 km	0	19
			Prędkość	Czas	0 min.
			30 km/h		
Dystans		Kierunek	Informacje	Do końca	
Total	Pomiędzy				
	0,00		Wyjazd z próby		
	0,60		Skręć w lewo w kierunku Goławin		
	0,60		Skręć w lewo w drogę nr 62 w kierunku Warszawa		
	9,80		Jedź dalej w prawo drogą 62 w kierunku Warszawa		
	0,00		Jedź dalej drogą nr 62		

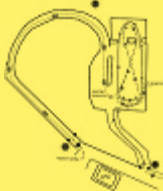
PKC	6	Goławin	Dystans	Etap 1	Strona
PKC	7	Nowy Dwór Mazowiecki	0,00 km	0	20
			Prędkość	Czas	0 min.
			30 km/h		
Dystans		Kierunek	Informacje	Do końca	
Total	Pomiędzy				
	7,80		Jedź prosto w drogę 85 w kierunku Warszawa		
	1,00		Na rondzie drugi zjazd w kierunku mostu		
	0,10		Skręć w lewo w drogę nr 631 w kierunku Centrum		
	0,57		Na rondzie trzeci zjazd w kierunku stacji LPG		
	0,14		Ustaw się za ostatnim autem w kolejce		

PKC	6	Goławin	Dystans	Etap 1	Strona
PKC	7	Nowy Dwór Mazowiecki	0,40 km	0	21
			Prędkość	Czas	1 min.
			30 km/h		
Dystans		Kierunek	Informacje	Do końca	
Total	Pomiędzy				
	0,40		PKC 7		
	0,00		PS 7		

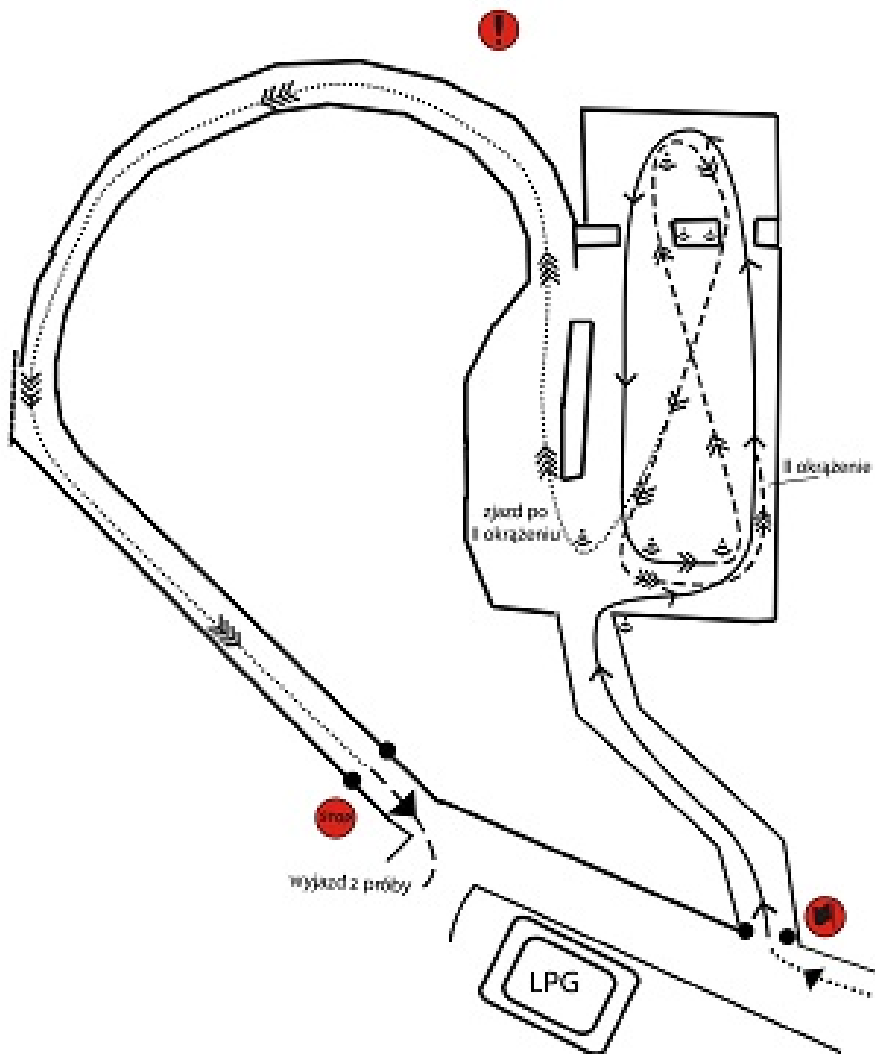
PKC	6	Goławin	Dystans	Etap 1	Strona
PKC	7	Nowy Dwór Mazowiecki	0,00 km	0	22
			Prędkość	Czas	0 min.
			30 km/h		
Nowy Dwór Mazowiecki					

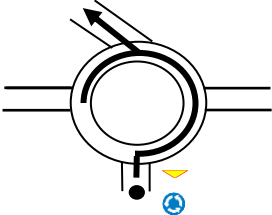
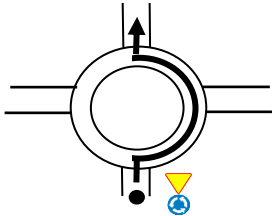
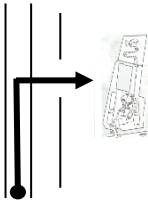

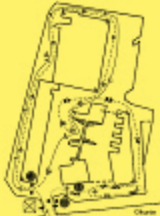

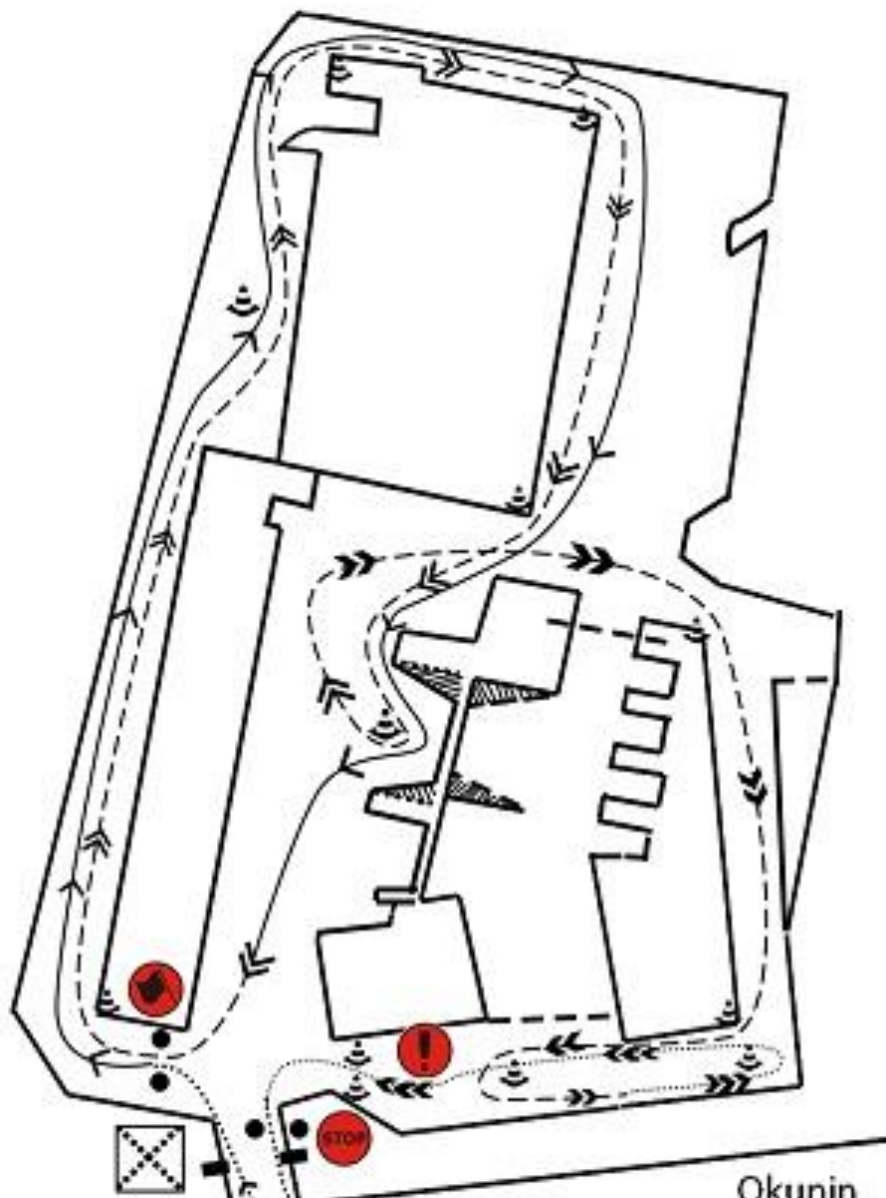

PKC	7	Nowy Dwór Mazowiecki	Dystans	Etap 1	Strona
PKC	8	Okunin	3,70 km	Sekcja 3	23
			Prędkość	Czas	7 min.
			30 km/h		
Dystans		Kierunek	Informacje	Do końca	
Total	Pomiędzy				
	0,50		Wyjazd z próby na rondzie drugi zjazd w ul. Modlińska		
	1,40		Na rondzie drugi zjazd ul Bohaterów Modlina		
	1,40		Wjazd na próbę		
	0,40		PKC 8		
	0,00		PS 8		

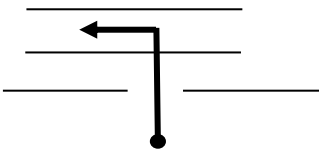
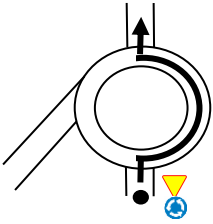
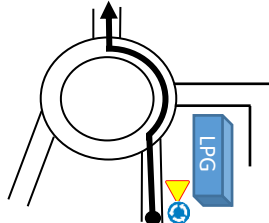
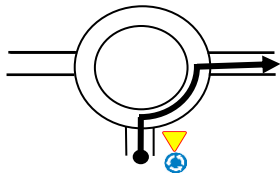
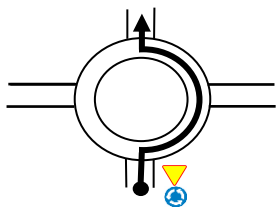
PKC	7	Nowy Dwór Mazowiecki	Dystans	Etap 1	Strona
PKC	8	Okunin	0,00 km	Sekcja 3	24
			Prędkość	Czas	0 min.
			30 km/h		
Okunin					

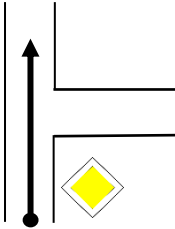
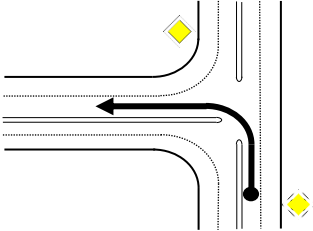

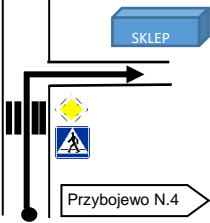
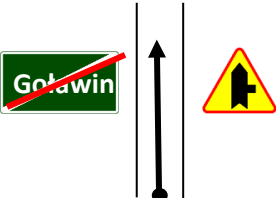
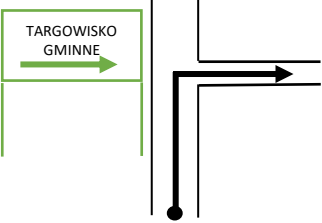
PKC PKC	8	Okunin	Dystans	Etap 1	Strona
	9	Goławin	0,00 km	0	25
			Prędkość	Czas	0 min.
			30 km/h		
Dystans		Kierunek	Informacje	Do końca	
Total	Pomiędzy				
	0,30		Wyjazd z próby		
	2,10		Na rondzie pierwszy zjazd ul. Bohaterów Modlina		
	0,55				
	0,20		Na rondzie pierwszy zjazd w drogę nr 85 w kierunku Płock		
	4,10				

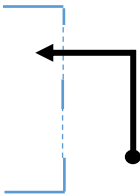
PKC PKC	8	Okunin	Dystans	Etap 1	Strona
	9	Goławin	0,00 km	0	26
			Prędkość 30 km/h	Czas	0 min.
Dystans		Kierunek			
	Total	Pomiędzy			
		1,00		Jedź prosto w drogę 62	
		9,80		Skręć w lewo w drogę nr 62 kierunek: Płock	
		0,60		Za przejściem dla pieszych skręć w prawo w kierunku Przybojowo N.	
		0,00			
		0,60			

PKC	8	Okunin	Dystans	Etap 1	Strona
PKC	9	Goławin	1,00 km	0	27
			Prędkość	Czas	2 min.
			30 km/h		
Dystans		Kierunek	Informacje	Do końca	
Total	Pomiędzy				
	0,60		Wjazd na próbę bramą nr 2		
	0,40		PKC 9		
	0,00		PS 9		

PKC	8	Okunin	Dystans	Etap 1	Strona
PKC	9	Goławin	0,00 km	0	28
			Prędkość	Czas	0 min.
			30 km/h		
Goławin					

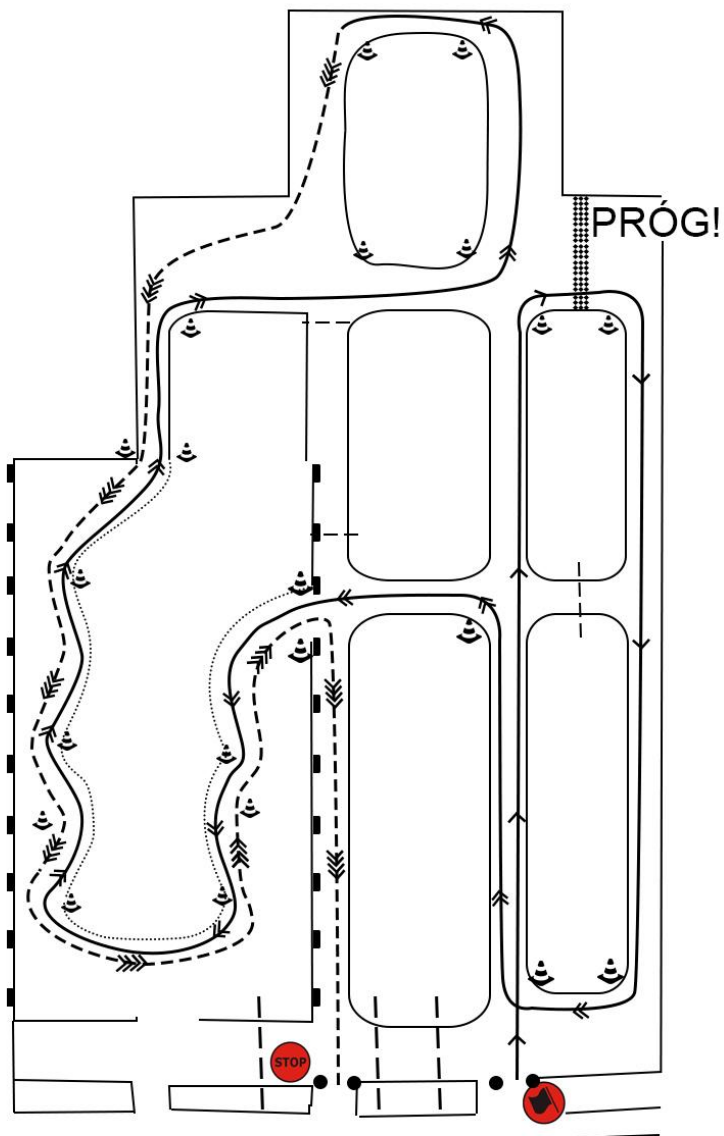

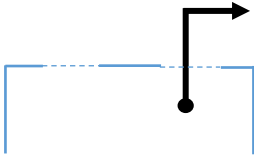
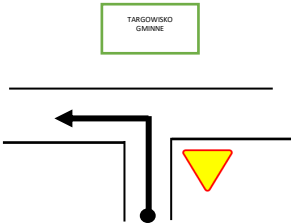
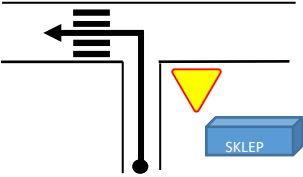
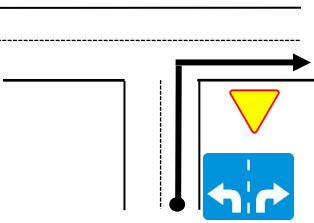
PKC	9	Goławin	Dystans	Etap 1	Strona
PKC	10	Zakroczym Karczma pod Jaworem	0,00 km	0	29
Prędkość				Czas	0 min.
				30 km/h	
Dystans		Kierunek	Informacje	Do końca	
Total	Pomiędzy				
	0,00		Wyjazd z próby		
	0,60		Skręć w lewo w kierunku Goławin		
	0,60		Skręć w lewo w drogę nr 62 w kierunku Warszawa		
	9,80		Jedź dalej w prawo drogą 62 w kierunku Warszawa		
	0,60	